

Part No:	GH-20752-B
Holding Capacity:	75Kg
Bar Opens:	96°
Handle Opens:	78°
Weight:	0.09Kg
Spindle Supplied:	SA-054008+NC-05
Flanged Washers:	FW-100

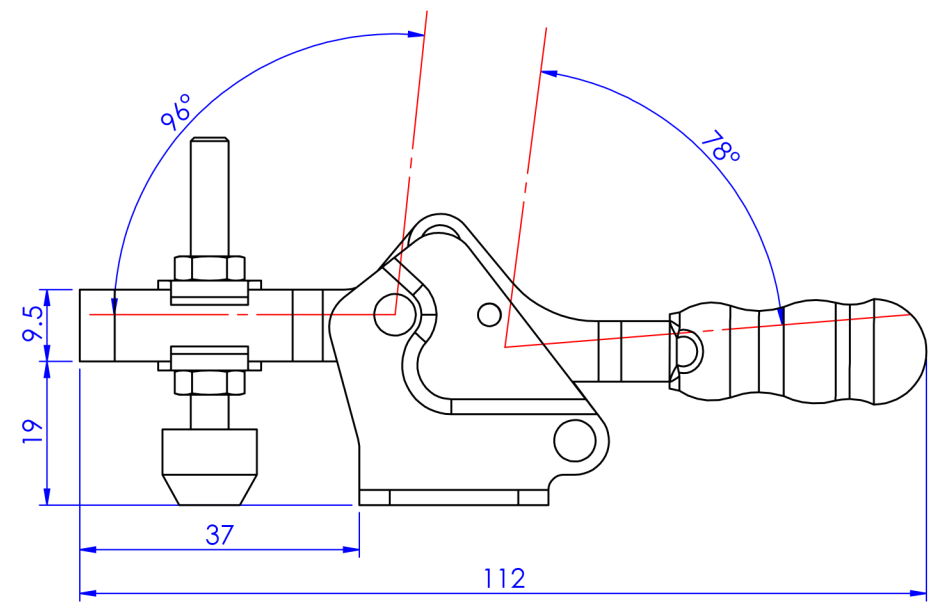
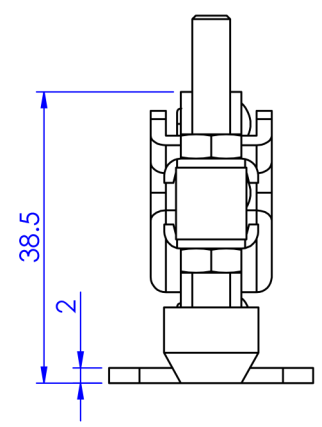
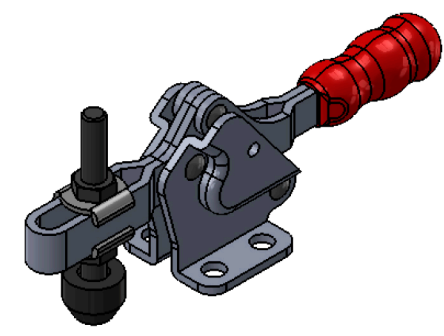
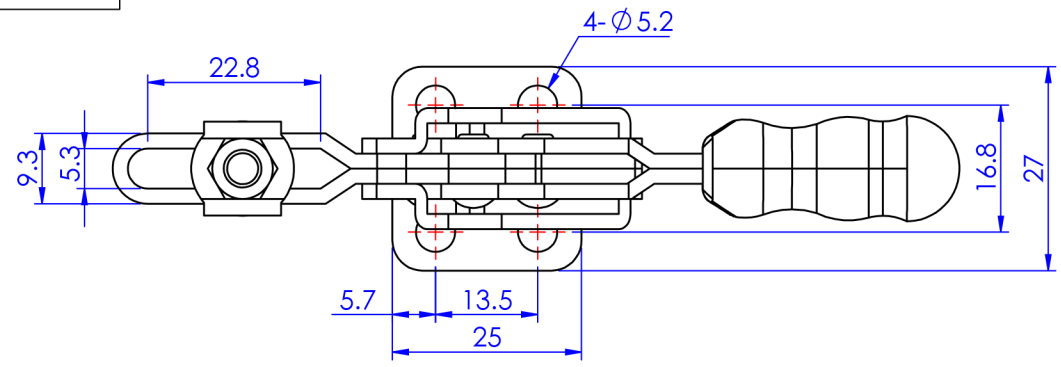

Unit:mm
Scale: 1:1

TITLE:	
DWG NO.	GH-20752-B
A4	